

Steckverbinder - Kunststoff für Profil 13,5x13,5 x 1,25mm Farbe: schwarz

Artikel Nr.:	Name	Material	für Profil:	Farbe	Stecktiefe
	MS2d2ku13 Winkel	Kunststoff	13,5mm	schwarz	20mm
	MS2d3ku13 T-Stück	Kunststoff	13,5mm	schwarz	20mm
	MS2d4ku13 Kreuz	Kunststoff	13,5mm	schwarz	20mm
	MS3d3ku13 Ecke	Kunststoff	13,5mm	schwarz	20mm
	MS3d4ku13 4-er	Kunststoff	13,5mm	schwarz	20mm
	MS3d5ku13 5-er	Kunststoff	13,5mm	schwarz	20mm
	MS3d6ku13 6-er	Kunststoff	13,5mm	schwarz	20mm

Steckverbinder für Profil 20 x 20 x 1,5mm - Kunststoff - Glasfaserverstärkt

Artikel Nr.:	Name	Material	für Profil:	Farbe	Stecktiefe	graue - ähnl. RAL 7035
 MS2d2ku20GF	Winkel	Kunststoff	20mm	schwarz	36mm	
 MS2d2ku20/gr	Winkel	Kunststoff	20mm	grau	30mm	
 MS2D2ku20/ok	Winkel ohne Kopf- 2 teilig	Kunststoff	20mm	schwarz	37mm	
 MS2d3ku20GF	T-Stück	Kunststoff	20mm	schwarz	36mm	
 MS2d3ku20/gr	T-Stück	Kunststoff	20mm	grau	30mm	
 MS2d4ku20GF	Kreuz	Kunststoff	20mm	schwarz	36mm	
 MS2d4ku20/gr	Kreuz	Kunststoff	20mm	grau	30mm	
 MS3d3ku20GF	Ecke	Kunststoff	20mm	schwarz	36mm	
 MS3d3ku20/gr	Ecke	Kunststoff	20mm	grau	30mm	
 MS3d4ku20GF	4-er	Kunststoff	20mm	schwarz	36mm	
 MS3d4ku20/gr	4-er	Kunststoff	20mm	grau	30mm	
 MS3d5ku20GF	5-er	Kunststoff	20mm	schwarz	36mm	
 MS3d5ku20/gr	5-er	Kunststoff	20mm	grau	30mm	
 MS3d6ku20GF	6-er	Kunststoff	20mm	schwarz	36mm	
MS/1d1V20/N	Zapfen	Kunststoff	20mm	natur	15mm	

Steckverbinder für Profil 20 x 20 x 1,5mm - Kunststoffbeschichtet mit Stahlkern

	Artikel Nr.:	Name	Material	für Profil:	Farbe	Stecktiefe
	MS2d2zn20	Winkel	mit Stahlkern	20mm	schwarz	36mm
	MS2D2zn20/ok	Winkel o.Kopf	mit Stahlkern	20mm	schwarz	37mm
	MS2D3zn20	T-Stück	mit Stahlkern	20mm	schwarz	36mm
	MS2D4zn20	Kreuz	mit Stahlkern	20mm	schwarz	36mm
	MS3D3zn20	Ecke	mit Stahlkern	20mm	schwarz	36mm
	MS3D4zn20	4-er	mit Stahlkern	20mm	schwarz	36mm
	3D5zn20	5-er	mit Stahlkern	20mm	schwarz	36mm
	MS3d6zn20	6-er	mit Stahlkern	20mm	schwarz	36mm
Gelenkverbinder - Polyamid - für 20x20x1,5mm Profile						
	MS2D2gel20	2er Gelenk	Verstellbereich 0-220°	20mm	schwarz	35mm
	MS2D3gel20	3er Gelenk	0-190°	20mm	schwarz	42mm
	MS2D4gel20	4er Gelenk	0-190°	20mm	schwarz	42mm
Steckverbinder Polyamid schwarz für Achtecke						
	MS2D2ku20/135	für 8-eck	135°	20mm	schwarz	28mm

Gelenkverbinder Polyamid - für Profile 25x25x1,5mm

Artikel Nr.:	Name	Stellbereich	Profil	Farbe	
MS2D2V25K/GEL-L-R	Gelenkverbinder minus 90° bis plus 90°		25mm	schwarz	
MS2D2gel25	2er Gelenk	0-190°	25mm	schwarz	
MS2D2gel25/45	2er Gelenk	45-195°	25mm	schwarz	
MS2D2gel25/45-Z	2er Gelenk	45-195° - Arretierbar	25mm	schwarz	
MS2D2gel25/OK	2er Gelenk	60-300° o.Kopf	25mm	schwarz	
MS2D2gel25/60	2er Gelenk**	0-60°	25mm	schwarz	
MS2D2gel25/45-RAL	2er Gelenk	45-195°	25mm	grau*	ähnl. RAL 7035
MS2D3gel25	3er Gelenk	0-190°	25mm	schwarz	
MS2D3gel25/45	3er Gelenk	45-195°	25mm	schwarz	
MS2D3gel25/45-Z	3er Gelenk	45-195° - Arretierbar	25mm	schwarz	
MS2D3gel25/OK	3er Gelenk	60-300° o.Kopf	25mm	schwarz	
MS2D3gel25/60	3er Gelenk **	0-60°	25mm	schwarz	
MS2D3gel25/45-RAL	3er Gelenk	45-195°	25mm	grau*	ähnl. RAL 7035
MS2D4gel25	4er Gelenk	0-190°	25mm	schwarz	
MS2D4gel25/45	4er Gelenk	45-195°	25mm	schwarz	
MS2D3gel25/45-Z	4er Gelenk	45-195° - Arretierbar	25mm	schwarz	
MS2D4gel25/OK	4er Gelenk	60-300° o.Kopf	25mm	schwarz	
MS2D4gel25/60	4er Gelenk **	0-60°	25mm	schwarz	
MS2D4gel25/45-RAL	4er Gelenk	45-195°	25mm	grau*	ähnl. RAL 7035

* ähnlich RAL 7035

60° Anschlusszapfen auf einer Linie - siehe auch Abbildung

Verbinder Kunststoff für Sechsecke und Achtecke - Farbe: schwarz

MS2D3ku25/120OK	6-Eck	120° o.Kopf	25mm	schwarz
MS2D3ku25/135OK	8-Eck	135° o.Kopf	25mm	schwarz
MS2D3ku25/135MK	8-Eck	135° m.Kopf	25mm	schwarz
MS2D2V25KU-45		45° Verbinder	25mm	schwarz

Steckverbinder für 25x25x1,5mm Profile - Kunststoff - Polyamid grau

Artikel Nr.:	Name	Material	Profil	Farbe	ähnl. RAL	Stecktiefe
MS2D2ku25gr	Winkel	Kunststoff	25mm	grau	7035	52mm
MS2D2ku25/9006	Winkel	Kunststoff	25mm	grau	9006	52mm



MS2D3ku25gr	T-Stück	Kunststoff	25mm	grau	7035	51mm
MS2D3ku25/9006	T-Stück	Kunststoff	25mm	grau	9006	51mm



MS3D3ku25gr	Ecke	Kunststoff	25mm	grau	7035	52mm
MS3D3ku25/9006	Ecke	Kunststoff	25mm	grau	9006	52mm



MS2D4ku25gr	Kreuz	Kunststoff	25mm	grau	7035	54mm
MS2D4ku25/9006	Kreuz	Kunststoff	25mm	grau	9006	54mm



MS3D4ku25gr	4er	Kunststoff	25mm	grau	7035	52mm
MS3D4ku25/9006	4er	Kunststoff	25mm	grau	9006	52mm



MS3D5ku25gr	5er	Kunststoff	25mm	grau	7035	54mm
MS3D5ku25/9006	5er	Kunststoff	25mm	grau	9006	54mm



MS/1D1V25/N	Erweiterungszapfen	Kunststoff	25mm		7035	15mm
--------------------	--------------------	------------	------	--	------	------

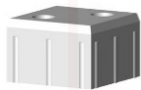











Steckverbinder für 25x25x1,5mm Profile - Kunststoff - Polyamid schwarz

<i>Artikel Nr.:</i>	<i>Name</i>	<i>Material</i>	<i>Profil</i>	<i>Farbe</i>	<i>Stecktiefe</i>
 MS2D2ku25	Winkel	Kunststoff	25mm	schwarz	52mm
 MS2D2ku25oK	Winkel o. Kopf	Kunststoff	25mm	schwarz	56mm
 MS2D2ku25R	Winkel - abgerundet	Kunststoff	25mm	schwarz	55mm
 MS2D3ku25	T -Stück	Kunststoff	25mm	schwarz	51mm
 MS3D3ku25	Ecke	Kunststoff	25mm	schwarz	52mm
 MS2D4ku25	Kreuz	Kunststoff	25mm	schwarz	54mm
 MS3D4ku25	4er	Kunststoff	25mm	schwarz	52mm
 MS3D5ku25	5er	Kunststoff	25mm	schwarz	54mm

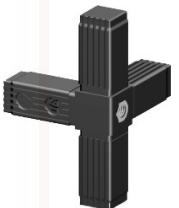

AL-SO-PLA

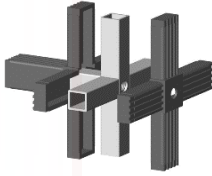
Steckverbinder für Profil 25 x 25 x 1,5mm - Kunststoffbeschichtet mit Stahlkern - verzinkt Farbe: schwarz

	Artikel Nr.:	Name	Ausführung	Profil	Farbe	Stecktiefe	
	MS2D2zn25	Winkel	Stahlkern verzinkt	25mm	schwarz	52mm	
	MS2D2zn25G	Winkel mit M10 Gewinde	Stahlkern verzinkt	25mm	schwarz	52mm	
	MS2D2zn25R	Winkel abgerundet	Stahlkern verzinkt	25mm	schwarz	52mm	
	MS2D2zn25oK	Winkel ohne Kopf	Stahlkern verzinkt	25mm	schwarz	56mm	
	MS2D3zn25	T-Stück	Stahlkern verzinkt	25mm	schwarz	51mm	
	MS2D3zn25G	T-Stück mit M10 Gewinde	Stahlkern verzinkt	25mm	schwarz	51mm	
	MS3D3zn25	Ecke	Stahlkern verzinkt	25mm	schwarz	52mm	
	MS3D3zn25G	Ecke mit M10 Gewinde	Stahlkern verzinkt	25mm	schwarz	52mm	
	MS2D4zn25	Kreuz	Stahlkern verzinkt	25mm	schwarz	54mm	
	MS3D4zn25	4er	Stahlkern verzinkt	25mm	schwarz	52mm	
	MS3D4zn25G	4er mit M10 Gewinde	Stahlkern verzinkt	25mm	schwarz	52mm	
	MS3D5zn25	5er	Stahlkern verzinkt	25mm	schwarz	54mm	
	MS3D5zn25G	5er mit M10 Gewinde	Stahlkern verzinkt	25mm	schwarz	54mm	
	MS3D6zn25	Stern	Stahlkern verzinkt	25mm	schwarz	52mm	

Steckverbinder für Profil 25 x 25 x 1,5mm - Kunststoffbeschichtet m. Stahlkern - verzinkt Farbe: grau

Artikel Nr.:	Name	Ausführung	Profil	RAL	Stecktiefe
MS2D2zn25/9006	Winkel	Stahlkern verzinkt	25mm	9006	52mm
MS2D2zn25G/9006	Winkel	mit M10 Gewinde Stahlkern verzinkt	25mm	9006	52mm
MS2D2zn25gr	Winkel	Stahlkern verzinkt	25mm	7035	52mm
MS2D2zn25G/gr	Winkel	mit M10 Gewinde Stahlkern verzinkt	25mm	7035	52mm



MS2D3zn25/9006	T-Stück	Stahlkern verzinkt	25mm	9006	51mm
MS2D3zn25G/9006	T-Stück	mit M10 Gewinde Stahlkern verzinkt	25mm	9006	51mm
MS2D3zn25gr	T-Stück	Stahlkern verzinkt	25mm	7035	51mm
MS2D3zn25G/gr	T-Stück	mit M10 Gewinde Stahlkern verzinkt	25mm	7035	51mm



MS3D3zn25/9006	Ecke	Stahlkern verzinkt	25mm	9006	52mm
MS3D3zn25G/9006	Ecke	mit M10 Gewinde Stahlkern verzinkt	25mm	9006	52mm
MS3D3zn25gr	Ecke	Stahlkern verzinkt	25mm	7035	52mm
MS3D3zn25G/gr	Ecke	mit M10 Gewinde Stahlkern verzinkt	25mm	7035	52mm



MS2D4zn25/9006	Kreuz	Stahlkern verzinkt	25mm	9006	54mm
MS2D4zn25gr	Kreuz	Stahlkern verzinkt	25mm	7035	54mm



MS3D4zn25/9006	4er	Stahlkern verzinkt	25mm	9006	52mm
MS3D4zn25G/9006	4er	mit M10 Gewinde Stahlkern verzinkt	25mm	9006	52mm
MS3D4zn25gr	4er	Stahlkern verzinkt	25mm	7035	52mm
MS3D4zn25G/gr	4er	mit M10 Gewinde Stahlkern verzinkt	25mm	7035	52mm





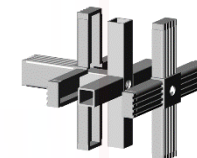







MS3D5zn25/9006	5er	Stahlkern verzinkt	25mm	9006	54mm
MS3D5zn25G/9006	5er	mit M10 Gewinde Stahlkern verzinkt	25mm	9006	54mm
MS3D5zn25gr	5er	Stahlkern verzinkt	25mm	7035	54mm
MS3D5zn25G/gr	5er	mit M10 Gewinde Stahlkern verzinkt	25mm	7035	54mm

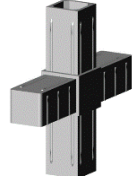

Artikel Nr.: Name Material für Profil: Farbe

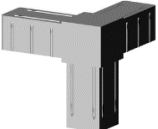
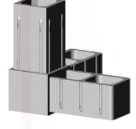
Steckverbinder -Polyamid für 25x25x2mm Profilrohre

Kunststoff - für mittlere Belastungen

Artikel Nr.:	Name	Material	für Profil:	Farbe
	MS2D2V25KU-2 Winkel	Kunststoff	25x25x2mm	grau
	MS2D2V25KU-2S Winkel	Kunststoff	25x25x2mm	schwarz
	MS2D3V25KU-2 T-Stück	Kunststoff	25x25x2mm	grau
	MS2D3V25KU-2S T-Stück	Kunststoff	25x25x2mm	schwarz
	MS2D4V25KU-2 Kreuz	Kunststoff	25x25x2mm	grau
	MS2D4V25KU-2S Kreuz	Kunststoff	25x25x2mm	schwarz
	MS3D3V25KU-2 3er	Kunststoff	25x25x2mm	grau
	MS3D3V25KU-2S 3er	Kunststoff	25x25x2mm	schwarz
	MS3D4V25KU-2 4er	Kunststoff	25x25x2mm	grau
	MS3D4V25KU-2S 4er	Kunststoff	25x25x2mm	schwarz
	MS3D5V25KU-2 5er	Kunststoff	25x25x2mm	grau
	MS3D5V25KU-2S 5er	Kunststoff	25x25x2mm	schwarz
	MS3D6V25KU-2S 6er - Stern	Kunststoff	25x25x2mm	schwarz

Achtung - Sonderverbinder - wir führen hierzu keine Profile!

Gelenkverbinder Polyamid - für Profile 30mm

Artikel Nr.:	Name	Ausführung Stellbereich	Material	Profil	Farbe	Stecktiefe
	MS2D2gel30 2er Gelenk	45-200°	Kunststoff	30x2mm	schwarz	41mm
	MS2D2gel30- 2er Gelenk	0-190°	Kunststoff *	30x2mm	schwarz	41mm



	MS2D2gel30- 2er Gelenk	45-200°	Kunststoff	30x4,5mm	schwarz	41mm
--	-------------------------------	---------	------------	----------	---------	------



	MS2D3gel30 3er Gelenk	45-200°	Kunststoff	30x2mm	schwarz	41mm
--	------------------------------	---------	------------	--------	---------	------



	MS2D4gel30 4er Gelenk	45-200°	Kunststoff	30x2mm	schwarz	41mm
--	------------------------------	---------	------------	--------	---------	------

* Glasfaserverstärkt =30% Glasfaser

Gelenkverbinder - Polyamid - für 40x40x2mm Profile

	MS2D2gel40 2er Gelenk	0-180°	40	schwarz	50mm	42mm
	MS2D2gel40- 2er Gelenk *	0-180°	40	schwarz	50mm	42mm



	MS2D3gel40 3er Gelenk	0-180°	40	schwarz	50mm	42mm
--	------------------------------	--------	----	---------	------	------



	MS2D4gel40 4er Gelenk	0-180°	40	schwarz	50mm	42mm
--	------------------------------	--------	----	---------	------	------



* Glasfaserverstärkt = 30% Glasfaseranteil

Achtung - Sonderverbinder 40mm - wir führen hierzu keine Profile!

Gelenkverbinder Polyamid - für Rundprofile 30x2mm & 30x3mm

Artikel Nr.:	Name	Stellbereich	Profil	Farbe	Stecktiefe	Zapfen
MS2D2gel-r30-2	2er Gelenk	45-200°	30x2mm	schwarz	41mm	42mm
MS2D2gel-r30-3	2er Gelenk	45-200°	30x3mm	schwarz	41mm	42mm



MS3D3gel-r30-2	3er Gelenk	45-200°	30x2mm	schwarz	41mm	42mm
MS3D3gel-r30-3	3er Gelenk	45-200°	30x3mm	schwarz	41mm	42mm



MS3D4gel-r30-2	4er Gelenk	45-200°	30x2mm	schwarz	41mm	42mm
MS3D4gel-r30-3	4er Gelenk	45-200°	30x3mm	schwarz	41mm	42mm

Gelenkverbinder Polyamid - für Rundprofile 40x2mm

MS2D2gel-r4-2	2er Gelenk	45-200°	40x2mm	schwarz	41mm	44mm
----------------------	------------	---------	--------	---------	------	------











MS3D3gel-r40-2	3er Gelenk	45-200°	40x2mm	schwarz	41mm	44mm
-----------------------	------------	---------	--------	---------	------	------









MS3D4gel-r40-2	4er Gelenk	45-200°	40x2mm	schwarz	41mm	44mm
-----------------------	------------	---------	--------	---------	------	------

Achtung - Sonderverbinder - wir führen hierzu keine Profile!

Steckverbinder für 30 x 30 x 2mm Profile - Kunststoff -Polyamid - Farbe: schwarz 2-teilig

<i>Artikel Nr.:</i>	<i>Name</i>	<i>Ausführung</i>	<i>Material</i>	<i>Profil</i>	<i>Farbe</i>	<i>Stecktiefe</i>
 MS2D2ku30	Winkel		Kunststoff	30mm	schwarz	47mm
 MS2D2ku30ok	Winkel	o.Kopf	Kunststoff	30mm	schwarz	47mm
 MS2d3ku30	T-Stück		Kunststoff	30mm	schwarz	47mm
 MS2d4ku30	Kreuz		Kunststoff	30mm	schwarz	47mm
 MS3d3ku30	Ecke		Kunststoff	30mm	schwarz	47mm
 MS3d4ku30	4-er		Kunststoff	30mm	schwarz	47mm
 MS3d5ku30	5-er		Kunststoff	30mm	schwarz	47mm
 MS3d6ku30	6-er		Kunststoff	30mm	schwarz	47mm

Steckverbinder für Profil 30 x 30 x 2mm - Kunststoffbeschichtet mit Stahlkern - verzinkt. Farbe:schwarz

Artikel Nr.:	Name	Ausführung	Profil	Farbe	Stecktiefe
 MS2D2zn30	Winkel		Stahlkern verz.	30mm	schwarz 47mm
MS2D2zn30G	Winkel	mit M10 Gewinde	Stahlkern verz.	30mm	schwarz 47mm
MS2D2zn30ok	Winkel	o.Kopf	Stahlkern verz.	30mm	schwarz 47mm
 MS2d3zn30	T-Stück		Stahlkern verz.	30mm	schwarz 47mm
MS2d3zn30/G	T-Stück	mit M10 Gewinde	Stahlkern verz.	30mm	schwarz 47mm
 MS2d4zn30	Kreuz		Stahlkern verz.	30mm	schwarz 47mm
 MS3d3zn30	Ecke		Stahlkern verz.	30mm	schwarz 47mm
MS3d3zn30/G	Ecke	mit M10 Gewinde	Stahlkern verz.	30mm	schwarz 47mm
 MS3d4zn30	4-er		Stahlkern verz.	30mm	schwarz 47mm
MS3d4zn30G	4-er	mit M10 Gewinde	Stahlkern verz.	30mm	schwarz 47mm
 MS3d5zn30	5-er		Stahlkern verz.	30mm	schwarz 47mm
MS3d5zn30/G	5-er	mit M10 Gewinde	Stahlkern verz.	30mm	schwarz 47mm
 MS3d6zn30	6-er		Stahlkern verz.	30mm	schwarz 47mm

Steckverbinder für 30 x 30 x 1,5mm Profile - Kunststoff - Polyamid - Farbe: schwarz
 Kunststoff - für mittlere Belastungen



Artikel Nr.:	Name	Material	für Profil:	Farbe
MS2D2ku30x15	Winkel	Kunststoff	30x30x1,5mm	schwarz



MS2D3ku30x15	T Stück	Kunststoff	30x30x1,5mm	schwarz
---------------------	---------	------------	-------------	---------



MS2D4ku30x15	Kreuz	Kunststoff	30x30x1,5mm	schwarz
---------------------	-------	------------	-------------	---------



MS3D3ku30x15	3 er	Kunststoff	30x30x1,5mm	schwarz
---------------------	------	------------	-------------	---------



MS3D4ku30x15	4 er	Kunststoff	30x30x1,5mm	schwarz
---------------------	------	------------	-------------	---------



MS3D5ku30x15	5 er	Kunststoff	30x30x1,5mm	schwarz
---------------------	------	------------	-------------	---------



MS3D6ku30x15	6 er	Kunststoff	30x30x1,5mm	schwarz
---------------------	------	------------	-------------	---------

Achtung - Sonderverbinder - wir führen hierzu keine Profile!

Beschreibung und detaillierte Abbildungen der Gelenkverbinder

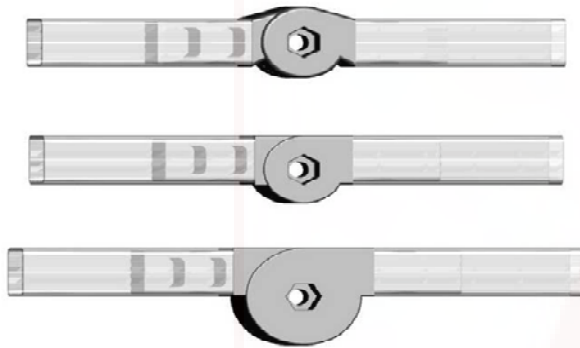

Gelenkverbinder 60° - Gelenk mittig
senkrechte Rohre in einer Flucht mit
mit den Waagerechten



Gelenkverbinder 24Z/180° - Gelenk
seitlich versetzt. Senkrechte Profile
nicht in einer Flucht mit den Senkrechten

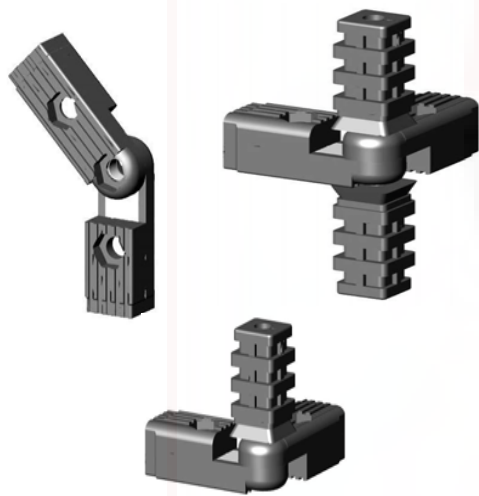
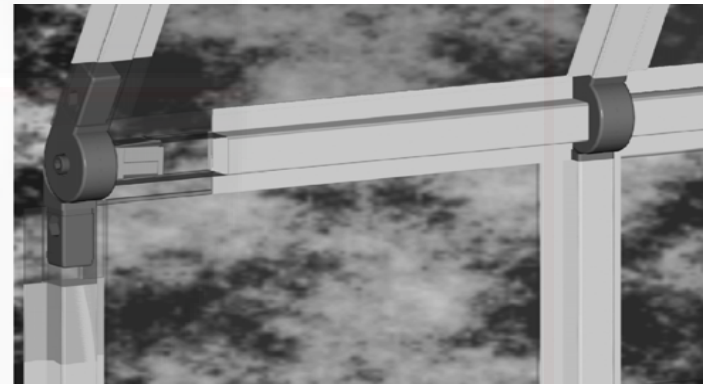

Gelenkverbinder ohne Kopf für unsichtbare Verbindungen

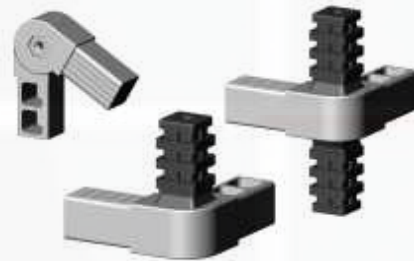



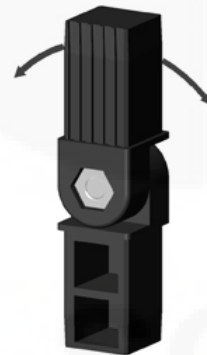



Gelenkverbinder grau ähnlich RAL 7035









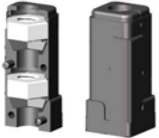

Gelenkverbinder minus 90° bis plus 90°

AL-SO-PLA

Zubehör für Verbinder,-Profile usw.

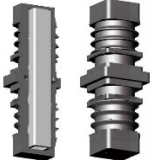
	Artikel Nr.:	Name	Farbe	Profil	Tragkraft
	MS/F-R20	Stellfuss mit Stopfen für Profilrohr 20x20x1,5mm	schwarz	20mm	
	MS/F-R25	Stellfuss mit Stopfen für Profilrohr 25x25x1,5mm	schwarz	25mm	
	MS/F-R30	Stellfuss mit Stopfen für Profilrohr 30x30x2mm	schwarz	30mm	
	MS/END20	Endstück für 20x20x1,5mm Profil	schwarz	20mm	
	MS/END25	Endstück für 25x25x1,5mm Profil	schwarz	25mm	
	MS/END30	Endstück für 30x30x2mm Profil	schwarz	30mm	
	MS/END16/RR	Endstück für 16 x1,5mm Rundrohr	schwarz	16mm	
	MS/END20/RR	Endstück für 20x2mm Rundrohr	schwarz	20mm	
		<i>Weitere Endstopfen auf Anfrage</i>			
	MS/StFuV	Stellfuss M10 Gewinde	L=65mm	bis 350Kg	
	MS/StFuV-8	Stellfuss mit M8 Gewinde	L=30mm	bis 350Kg	
	MS/StFM10/40-70	Stellfuß M10 Gewinde - Stellteller - drehbar 40mm	L = 70mm	bis 350Kg	
	MS/StFM8/40-70	Stellfuß M8 Gewinde - Stellteller - drehbar 40mm	L = 70mm	bis 350Kg	
	MS/StFM8/30-70	Stellfuß M8 Gewinde - Stellteller - drehbar 30mm	L = 70mm	bis 350Kg	
	MS/LR/50-1/FS	Lenkrolle Ø 50 mm aus Polyamid <i>mit M10 Gewindestück - mit Feststeller</i>	schwarz	bis 50Kg	
	MS/LR/50-1	Lenkrolle Ø 50 mm aus Polyamid <i>mit M10 Gewindestück - ohne Feststeller</i>	schwarz	bis 50Kg	
	MS/LR/50-a	Lenkrolle Ø 50 mm aus Polyamid - mit Aluminiumoptik und M10 Gewindestück - ohne Feststeller	schwarz/Alu	bis 50Kg	
	MS/LR/50-a/f	Lenkrolle Ø 50 mm aus Polyamid - mit Aluminiumoptik und M10 Gewindestück - mit Feststeller	schwarz/Alu	bis 50Kg	
	MS/vor3	Vorlegeband - Selbstklebend - hochwertiger Moosgummi 20 x 3mm.	schwarz		

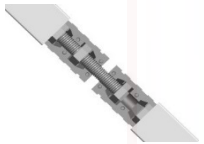
Zubehör für Verbinder,-Profile usw.

<i>Artikel Nr.:</i>	<i>Name</i>	<i>Farbe</i>	<i>Profil</i>
	MS/RoAnS/25G/oL	schwarz	25mm
	MS/RoAnS/30G/oL	schwarz	30mm
	<i>z.B. zum Anbauen von - Auflagen, um 2 Profile zu verbinden usw</i>		
	MS/RoAnS/25G/mL	schwarz	25mm
	MS/RoAnS/30G/mL	schwarz	30mm
	<i>z.B. zum Anbauen von Rollen - Stellfüßen usw</i>		
	MS/RoVe/25mB-5	schwarz	25mm
	Rohrverlängerung Stahlkern - Kunststoffummantelt Bund 5mm		
	MS/RoVe/25B	schwarz	25mm
	MS/RoVe/25B/GR	grau	25mm
	Rohrverlängerung für Profil 25x25x1,5mm mit Bund 25mm		
	MS/RoVe/25G		25mm
	2 Rohrverbinder mit Gewindestange für 25mm Profil ohne Bund		
	MS/3D1VV25/M10/2		25mm
	MS/3D1BVV25/M10/2		25mm
	Schraubekverbinder mit Gewinde M10 für Quadratrohr ohne Bund Schraubekverbinder mit Gewinde M10 für Quadratrohr mit Bund		

AL-SO-PLA